



Logiciels de calcul de structure

www.dlubal.fr

Webinaire

Modélisation d'une cuve et analyse des contraintes sur RFEM 6



M.Eng. Damien Taunay

Organisateur

Technico-commercial
Dlubal Software Sarl



M.Eng. Cosme Asseya

Co-Organisateur

Technico-commercial (Gérant)
Dlubal Software Sarl

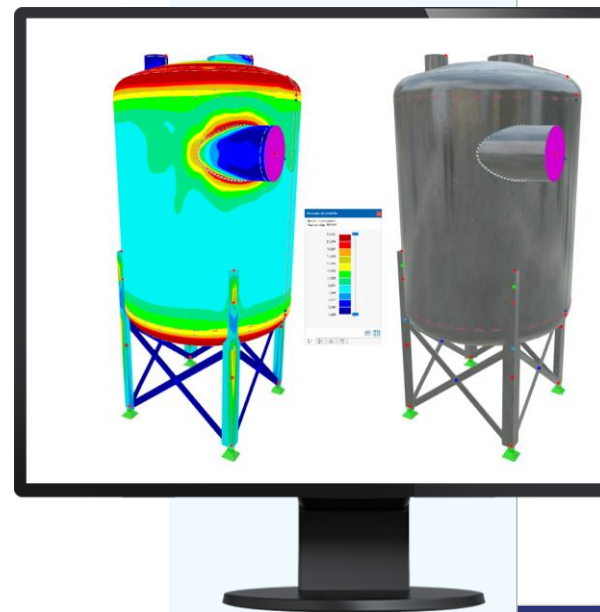

Questions pendant le webinaire

Fenêtre GoToWebinar **Bureau**

E-mail : info@dlubal.fr



Afficher/Masquer le panneau de contrôle



File View Help

Audio

Sound Check [Progress Bar] ?

Computer audio
 Phone call

MUTED

Mikrofon (2- Sennheiser USB h...)

Lautsprecher (2- Sennheiser U...)

Questions

[Enter a question for staff]

Send

Webinar ID: 373-901-987

GoToWebinar

Régler les paramètres audio



Poser vos questions





CONTENU

01 Modélisation et calcul d'une structure en tôle acier

02 Analyse des contraintes - déformations

03 Éléments représentatifs

04 Évaluation des résultats et documentation

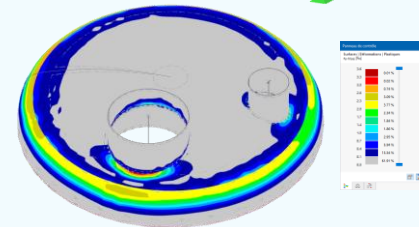
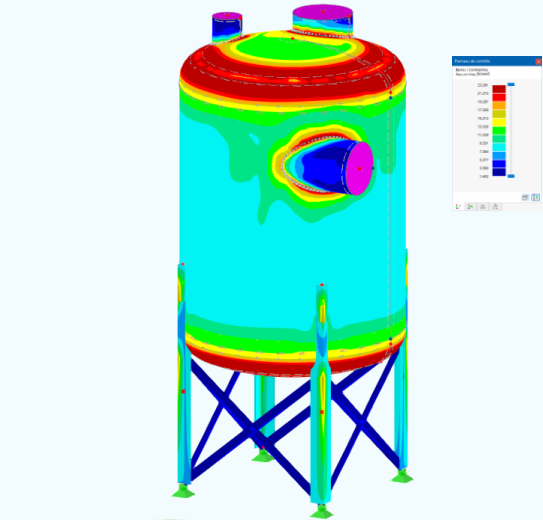
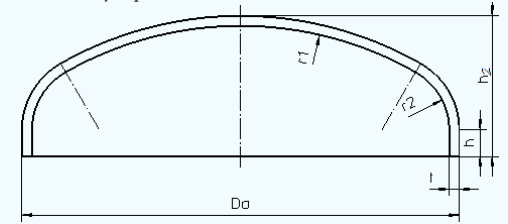



Services en ligne gratuits

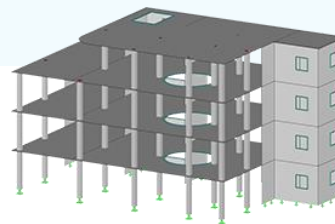

Geo-Zone-Tool

Dlubal Software met à la disposition des utilisateurs un outil de géolocalisation en ligne des zones de neige, de vent et de sismicité.

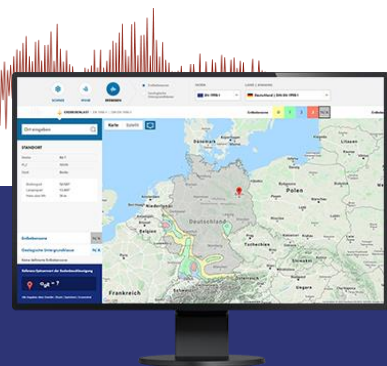

Propriétés de sections

Cet outil en ligne gratuit vous permet de sélectionner des profilés standards à partir d'une vaste base de données ou de définir des sections paramétriques et de calculer leurs propriétés.

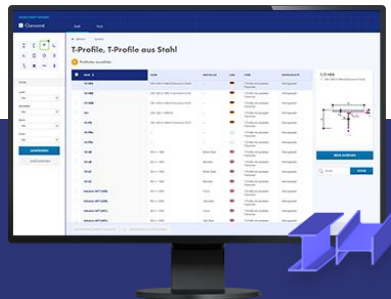

FAQs & Base de connaissance

Trouver les questions fréquemment posées à notre équipe du support technique ainsi que des conseils et astuces utiles dans nos articles techniques pour améliorer votre efficacité.

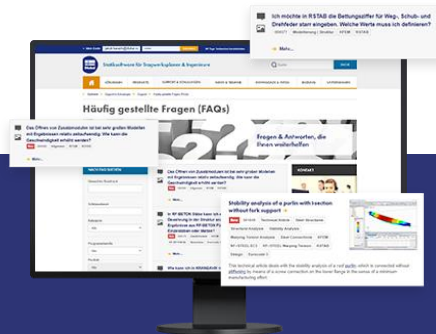

Modèles à télécharger

Vous trouverez ici un grand nombre d'exemples de modèles qui vous aideront à utiliser et à vous familiariser avec les programmes Dlubal.





Services en ligne gratuits

Chaîne Youtube, webinaires, vidéos

Regardez les vidéos et webinaires sur les logiciels de calcul de structures de Dlubal.

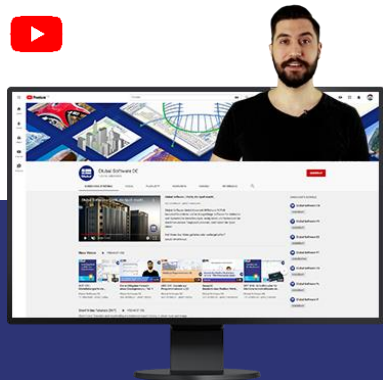

Boutique en ligne

Configurez votre progiciel et consultez tous les prix en ligne!



Version d'essai

La meilleure façon de découvrir nos programmes est de les tester. Téléchargez la version d'essai de 90 jours de nos programmes d'analyse structurelle.

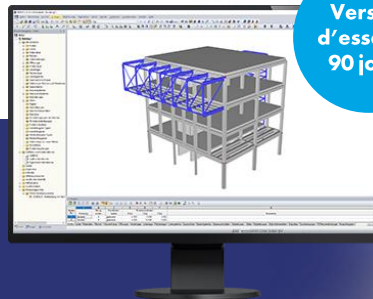

Version d'essai de 90 jours



Support technique gratuit par mail



Plus d'informations sur Dlubal



Site internet
www.dlubal.fr

- Vidéos et webinaires
- Newsletters
- Évènements et conférences
- Articles de la base de connaissance



Formez-vous
grâce aux
webinaires



Téléchargez
les versions
d'essais

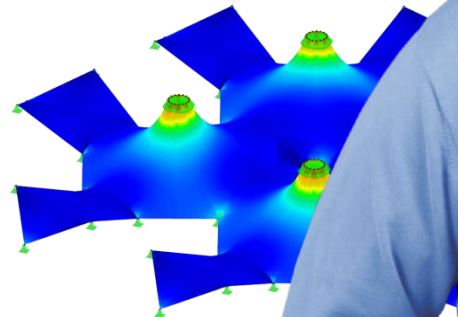

Dlubal Software SARL
11, Rue de Cambrai
75019 Paris
France

Tél. : +33 1 78 42 91 61
E-mail: info@dlubal.fr



www.dlubal.fr