

**Version
September 2013**

Add-on Module

RF-IMP

Generation of Equivalent Geometrical Imperfections and Pre-Deformed Initial Models

Program Description

All rights, including those of translations, are reserved.

No portion of this book may be reproduced – mechanically, electronically, or by any other means, including photocopying – without written permission of DLUBAL SOFTWARE GMBH.

© **Dlubal Software GmbH**
Am Zellweg 2 D-93464 Tiefenbach

Tel.: +49 9673 9203-0
Fax: +49 9673 9203-51
E-Mail: info@dlubal.com
Web: www.dlubal.com

Contents

Contents		Page	Contents		Page
1.	Introduction	4	3.2.2	Pre-Deformed Initial Model	20
1.1	Add-on Module RF-IMP	4	3.3	Export of Imperfections	21
1.2	RF-IMP Team	5	3.3.1	Imperfections	21
1.3	Using the Manual	5	3.3.2	Pre-Deformed FE Mesh	22
1.4	Open the Add-on Module RF-IMP	6	4.	General Functions	24
2.	Input Data	7	4.1	RF-IMP cases	24
2.1	General Data	8	4.2	Units and Decimal Places	26
2.2	Imperfections	10	4.3	Export of Data	26
3.	Generation	15	5.	Example: Pre-Deformed Model	28
3.1	Start the Generation	15	A	Literature	31
3.2	Generated Imperfections	18	B	Index	32
3.2.1	Imperfections	18			

1. Introduction

1.1 Add-on Module RF-IMP

Many standards consider imperfections in analysis of second order effects. For this purpose, you can select between two options: You can define equivalent loads, as provided for example in the standards EN 1993-1-1, clause 5.3. Alternatively, you can perform the analysis on an equivalent model whose FE and system nodes are displaced according to the standard. Both options are provided in the RFEM add-on module RF-IMP.

The pre-deformations have to be applied in the most unfavorable directions of action. For small structural systems, this method may be still manageable so that imperfections can be defined manually. For large systems with surface and solid elements, this approach has its limits, because the rules for the calculation of equivalent loads exist only for member elements. RF-IMP is able to generate the governing imperfections for RFEM, based on deformations, buckling shapes, or eigenvibrations in the form of equivalent models.

RF-IMP allows you to analyze different RF-IMP cases for imperfections quickly and efficiently. This guarantees the standard-conforming application in the most unfavorable directions. Moreover, the implementation of the cross-sectional buckling curves according to Eurocode 3 proves to be a useful feature.

You need to specify only a few things in the two input windows of RF-IMP. From these specifications, the module generates the imperfections in the governing direction. Before the generated imperfections are exported to RFEM, you can graphically check them at the RFEM model. Normally, the equivalent imperfections are defined in a separate imperfection load case, which can then be added in a load combination accordingly. If you generate a pre-defined initial model, the shifted FE nodes can be applied as parameters for the calculation of a load combination. This has the advantage that the model data is not changed. Thus, you can consider different pre-deformed initial models in one RFEM model.

You can export the RF-IMP tables directly to MS Excel or OpenOffice.org Calc for further use or storage.

Like other add-on modules, RF-IMP is completely integrated in the main program RFEM. It is also possible to generate all equivalent imperfections quickly and comfortably by accessing the results from RFEM (deformations of load cases, load combinations, and result combinations), RF-STABILITY (buckling modes), and RF-DYNAM (eigenmodes).

We hope you will enjoy working with RF-IMP.

Your DLUBAL Team

1.2 RF-IMP Team

The following people were involved in the development of RF-IMP:

Program coordination

Dipl.-Ing. Georg Dlubal

Dipl.-Ing. (FH) Younes El Frem

Programming

DiS. Jiří Šmerák

Program design, dialog figures, and icons

MgA. Robert Kolouch

Ing. Jan Miléř

Program supervision

Ing. František Knobloch

M.Eng. Dipl.-Ing. (BA) Andreas Niemeier

Localization, manual

Ing. Fabio Borriello

Ing. Dmitry Bystrov

Eng.º Rafael Duarte

Ing. Jana Duníková

Ing. Lara Freyer

Alessandra Grosso

Bc. Chelsea Jennings

Ing. Ladislav Kábrt

Ing. Aleksandra Kociolek

Ing. Roberto Lombino

Eng.º Nilton Lopes

Ing. Téc. Ind. José Martínez

MA Translation Anton Mitleider

Dipl.-Ü. Gundel Pietzcker

Mgr. Petra Pokorná

Ing. Michaela Prokopová

Ing. Marcela Svitáková

Dipl.-Ing. (FH) Robert Vogl

Ing. Marcin Wardyn

Technical support and quality management

M.Eng. Cosme Asseya

Dipl.-Ing. (BA) Markus Baumgärtel

Dipl.-Ing. Moritz Bertram

Dipl.-Ing. (FH) Steffen Clauß

Dipl.-Ing. Frank Faulstich

Dipl.-Ing. (FH) René Flori

Dipl.-Ing. (FH) Stefan Frenzel

Dipl.-Ing. (FH) Walter Fröhlich

Dipl.-Ing. (FH) Bastian Kuhn

Dipl.-Ing. (FH) Ulrich Lex

Dipl.-Ing. (BA) Sandy Matula

Dipl.-Ing. (FH) Alexander Meierhofer

M.Eng. Dipl.-Ing. (BA) Andreas Niemeier

M.Eng. M.Eng. Dipl.-Ing. (FH) Walter Rustler

M.Sc. Dipl.-Ing. (FH) Frank Sonntag

Dipl.-Ing. (FH) Robert Vogl

1.3 Using the Manual

Topics like installation, graphical user interface, results evaluation, and printout report are described in detail in the RFEM manual. The present manual focuses on typical features of the RF-IMP add-on module.



The manual follows the sequence and structure of the module's input and results windows. The text shows the described **buttons** in square brackets, for example [Import All Members]. In addition, they are pictured on the left. The **Expressions** appearing in dialog boxes, tables, and menus are set in *italics* to clarify the explanations.

At the end of the manual, you find the index. However, if you still cannot find what you are looking for, please check our website www.dlubal.com where you can go through our comprehensive *FAQ* pages by selecting particular criteria.

1.4 Open the Add-on Module RF-IMP

RFEM provides the following options to start the add-on module RF-IMP.

Menu

You can start the add-on module by using the command from the RFEM menu

Add-on Modules → Others → RF-IMP.

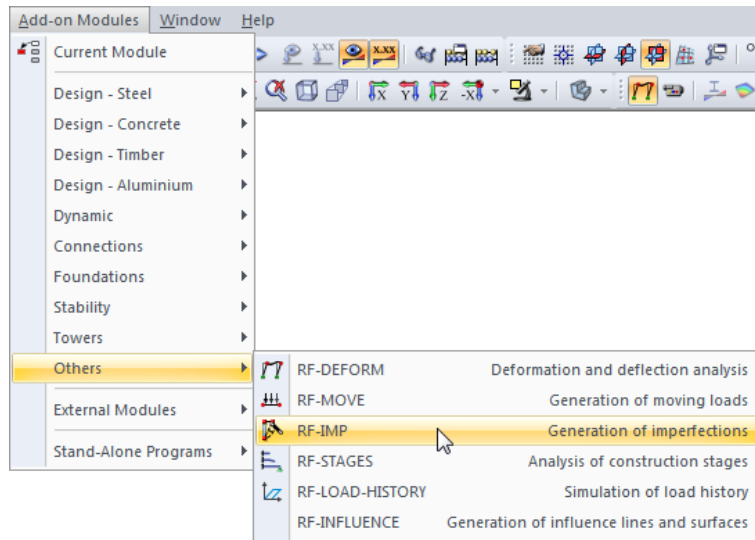

Figure 1.1: Menu: Add-on Modules → Others → RF-IMP

Navigator

You can also start RFIMP from the *Data* navigator by clicking the item

Add-on Modules → RF-IMP.

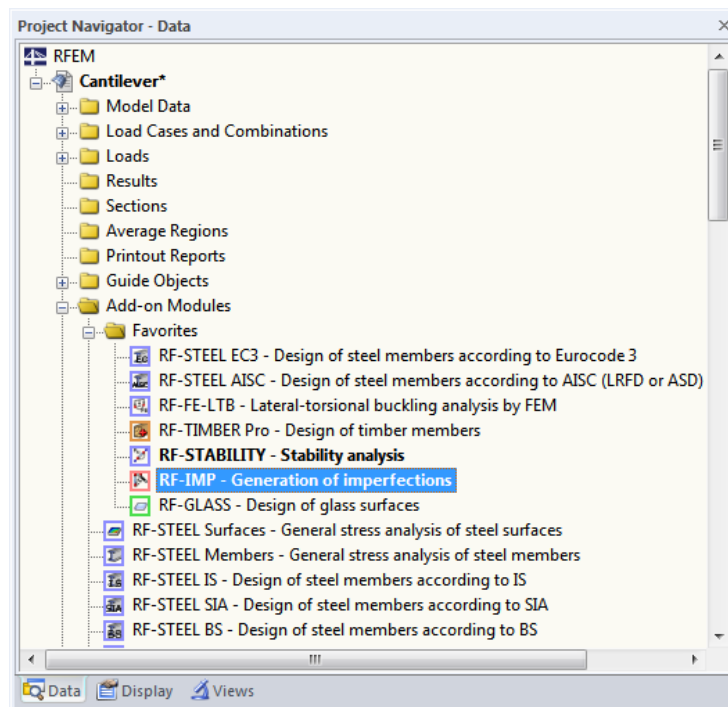

Figure 1.2: Data navigator: Add-on Modules → RF-IMP

2. Input Data

When you open the add-on module, a new window appears. On the left, you see a navigator containing all available module windows. Above the navigator, there is a drop-down list with the RF-IMP cases (see chapter 4.1, page 24).

The data relevant for the imperfections is to be defined in two input windows. When you open RF-IMP for the first time, the following parameters are automatically imported:

- Members and sets of members
- Load cases, load combinations, and result combinations



To go to a module window, click the respective entry in the navigator. To select the previous or next window, use the buttons shown on the left. You can also use the function keys [F2] and [F3] to browse through the module windows.



To save the results, click [OK]. Thus, you exit RF-IMP and return to the main program. To exit the module without saving the input data, click [Cancel].

2.1 General Data

In the 1.1 *General Data* window, you define the basic data for the generation of imperfections as well as the type of generation.

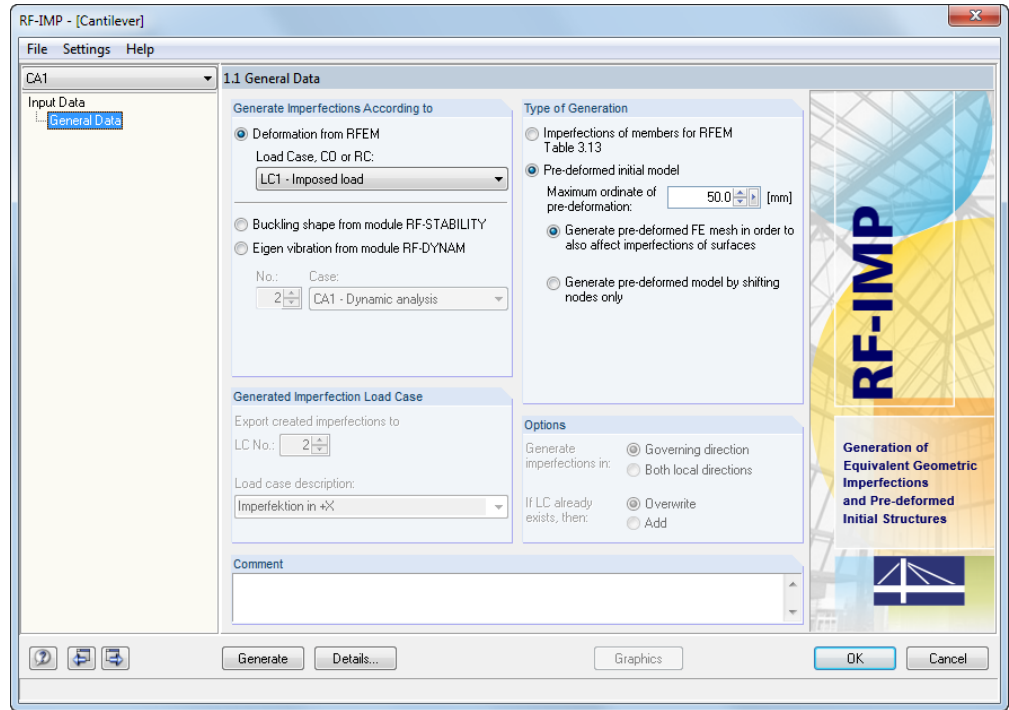

Figure 2.1: Window 1.1 *General Data*

Generate Imperfections According to

First, you have to decide which results you want to use as a basis for generating imperfections or the pre-deformed initial model. There are three options in this dialog box section.

Deformation from RFEM

You can select the governing load in the *Load Case, CO or RC* list.

For result combinations, there are two result values at every x-location: the minimum and maximum of the superimposed values. For this reason, the list provides two entries for one result combination: *RC+* (maximum) and *RC-* (minimum), as shown in the picture.

EN 1993-1-1 clause 5.3.2 (1) requires setting the equivalent geometric imperfections affine with the lowest buckling mode. Consequently, it would be necessary to create a separate imperfection load case for each loading in a distinct direction with a corresponding deformation. The RF-IMP cases (see chapter 4.1, page 24) offer you the possibility to generate imperfections taking into account different directions of deformation.

Buckling shape from module RF-STABILITY

Imperfections can be generated in such a way that they conform as much as possible to the deformation that belongs to the lowest buckling eigenvalue. To use the buckling mode, you must have a RF-STABILITY license.

In the *No.* list, you can select the number of the relevant buckling mode. In the *Case* list, you select the governing generated case from RF-STABILITY.

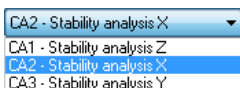
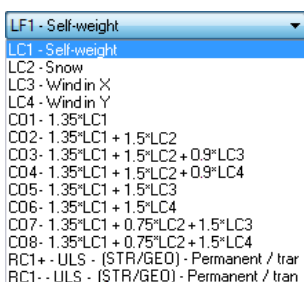

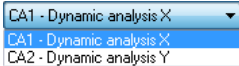

Eigen vibration from module RF-DYNAM

The imperfections or the pre-deformed initial model can also be based on an eigenmode that has been determined by the add-on module RF-DYNAM. To use the eigenvibrations, you need a license for the module RF-DYNAM Basis.

In the *Case* list, you define the governing RF-DYNAM analysis case. The eigenvibration used to generate the imperfections can be set in the *No.* input field.

If there are no results from RFEM, RF-STABILITY, or RF-DYNAM available, RF-IMP automatically determines the relevant deformations, buckling and plate-buckling modes, or eigenvibrations during the generation of the imperfections.

Type of Generation

The imperfections can be generated in two completely different ways. Depending on the selection, certain parts in this dialog box are activated in the 1.1 *General Data* window.

Equivalent imperfections of members for RFEM table 3.13

The program creates a load case with equivalent imperfections in accordance with Eurocode or DIN 18800, for members or sets of members. This load case can then be considered in a load combination.

If you select this type of generation, further specifications are required in the dialog box sections *Generated Imperfection Load Case* and *Options* as well as in the 1.2 *Imperfections* window.

Pre-deformed initial model

If you select this generation option, the program scales the normalized deformations from RFEM, RF-STABILITY, or RF-DYNAM to the *Maximum ordinate of pre-deformation* that you specify in the input field. No further specifications are required. There are two options for selection:

- **Generate pre-deformed FE mesh**

For every FE node, the program determines a pre-deformation that lies between the maximum ordinate. In the calculation parameters of RFEM, you can assign an RF-IMP case (see chapter 3.3.2, page 22). If you calculate this load combination according to second-order analysis or large deformation analysis, the FE mesh is deformed according to the RF-IMP case. The model data from RFEM (nodal coordinates) remains unchanged.

- **Generate pre-deformed model by shifting nodes**

The nodal coordinates in the RFEM table 1.1 are shifted according to the specified deformation. For this type of generation, only a single imperfection mode can be considered: The nodes can be displaced only a single time.

Pre-deformed initial models are particularly well suited for surface and shell models.

Generated Imperfection Load Case

This dialog box section is available only for the *Imperfections of members* generation type.

The *LC No.* determines which imperfections are exported after the generation. The first free load case number is preset. You can enter the *Load case description* directly or select in from the list.

If you export the load case to RFEM, an according query appears (see chapter 3.3, page 21).

Options

This dialog box section is available only for the *Imperfections of members* generation type.

The imperfections can be generated in the *Governing direction* or in *Both local directions*. If you select the first option (default), RF-IMP applies the imperfection only in one direction, that is, either in the direction of the local member axis y or z. The tolerance (see chapter 3.1, page 15) determines from which point on a deformation or deflection of an eigenmode is "governing".

Details...

Click [Details] to check the defined tolerances that are also valid in the generation of both local directions.

If the number of an already existing load case is specified in the *Generated Imperfection Load Case* section, two additional options become available. Use them to decide if you want RF-IMP to *Overwrite* the already existing load case or *Add* the generated equivalent imperfections to the existing loads.

Comment

This input field is available for a user-defined comment, for example to describe the parameters used in the current RF-IMP case.

2.2 Imperfections

The second window appears if you specify the Imperfections of members for RFEM Table 3.4 in the 1.1 *General Data* window.

The window consists of two tables: The 1.2.1 *Generate Imperfections of Members* table manages the members relevant for generation, while the 1.2.2 *Generate Imperfections of Sets of Members* table lists the sets of members to be considered (groups of members cannot be used for imperfections).

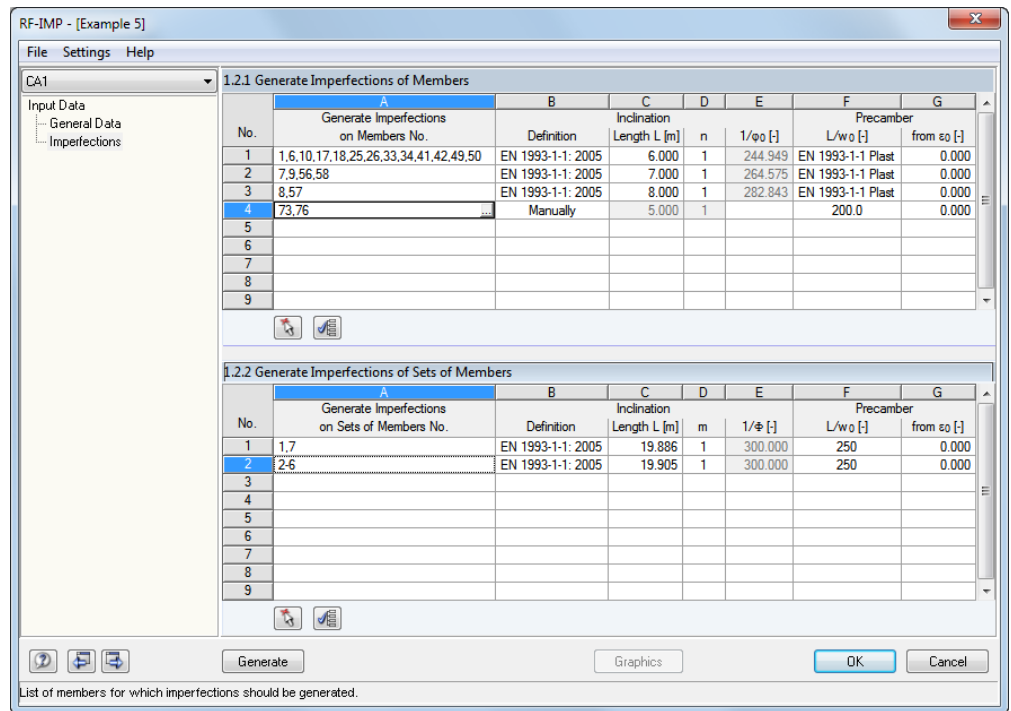
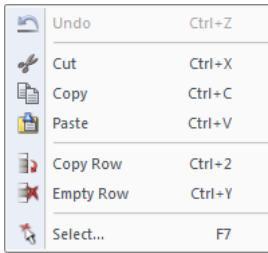

Figure 2.2: Window 1.2 Imperfections



Both tables offer the same input options. The specifications in window 1.2.1 apply to individual members, in window 1.2.2 to sets of members. For this reason, they are described in this chapter together.

You can edit the specifications by using the common keyboard functions. For example, you can delete the active table row (where the cursor is placed) by pressing [Ctrl]+[Y] (see RFEM manual, chapter 3.4.8) The context menu, which you open by right-clicking in a row, also provides important edit functions (see figure on the left).

To adjust the units and decimal places of lengths and loads, select *Units and Decimal Places* on the *Settings* menu (see chapter 4.2, page 26).

Imperfections of members / sets of members

In column A, you enter the numbers of the relevant members or sets of members.

Please note that sets of members must already be defined in RFEM in order to select them in the add-on module RF-IMP. It is not possible to create new sets of members in RF-IMP.

Clicking [\leftarrow] allows you to select the members and sets of members graphically in the RFEM work window. Alternatively, click in the input field to activate the [...] button (see Figure 2.2), which also allows you to go to the RFEM graphic window.

By clicking the members or sets of members in the RFEM work window, you import their numbers in the *Multiple Selection* dialog box. If you have selected the wrong member, you can remove it from the list by clicking the selected member again. On [OK], you import the numbers of the selected objects and return to RF-IMP.

Clicking [Import All] selects all members or sets of members for the generation and imports their numbers and lengths in the tables.

For sets of members, numbering and directions of the contained members are of no importance. However, it is important that all members in the set have the same member rotation.

Inclination

In table columns B through E, you specify the parameters for the inclination. The following definition types are available (see also picture on the left):

- DIN 18800 E-E (analysis method elastic-elastic)
- DIN 18800 E-P (analysis method elastic-plastic)
- EN 1992-1-1: 2004-12 (Eurocode 2)
- EN 1993-1-1: 2005-07 (Eurocode 3)
- DIN 10445-1: 2001-07
- DIN 1052: 2004-08
- Manually

Definition

In column B, you can select one of the standards mentioned above. Click into the input field to activate the [\blacktriangledown] button. Use this button to select the relevant setting from the list. You can also press [F7] to open the list.

In the Eurocode and the DINstandards, the value of the inclination $1/\varphi_0$ is entered automatically in column E.

Length L

The length L represents the system length of the imperfect member. This is taken into account in Equation 2.2 (see below).

In column C, the member lengths are preset. You can adjust them, if necessary. Clicking in the input fields allows you to select the members and sets of member graphically determine the length.

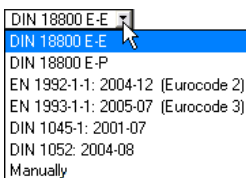

n or m

n or m represent the number of causes (columns), which are independent from one another, and which must be taken into account for the inclinations of members and sets of members. This is illustrated by Figure 5.2 in EN 1993-1-1, clause 5.3.2. Generally, for n you may set the number of frame posts per floor in the considered frame plane.

1/φ₀ or φ

If you select the definition type *Manually* in column B, you can enter the value of the inclination directly. In this case, the columns for *Length L* and n are unavailable.

If the inclination (sway) is determined automatically according to one of the two definition types for **DIN 18800**, it is normally determined for single members (non-built-up members) as follows:

$$\varphi_0 = \frac{1}{200} \cdot r_1 \cdot r_2$$

Equation 2.1: Inclination φ_0 according to DIN 18800 part 2, Eq. (1)

This method is based on the analysis method *elastic-plastic*. The two reductions factors r_1 and r_2 are determined as follows.

$$r_1 = \sqrt{\frac{5}{L}}$$

where L : System length of the member or set of members

Equation 2.2: Reduction factor r_1

Equation 2.2 applies only to lengths ≥ 5.00 m. For $l < 5.00$ m, r_1 is set to one.

$$r_2 = \frac{1}{2} \cdot \left(1 + \sqrt{\frac{1}{n}} \right)$$

where n : Number of causes for inclinations independent from one another

Equation 2.3: Reduction factor r_2

If you select the *elastic-elastic* method, the inclinations will be determined according to the same principle. However, because the stress analysis is performed based on the *elastic-elastic* method, like for example in the module RF-STEEL, the inclination may be reduced according to DIN 18800 part 2, to $\frac{2}{3}$ of the basic value (that is $\varphi_0 = \frac{1}{300}$). In this way, the fact is taken into account that the plastic reserve of the cross-section is not used.

Precamber L/w₀

In the table columns F and G, you define the parameters for the precamber. The following types of definition according to Eurocode and DIN 18800 are available: Click into the input field to activate the [▼] button. Use this button to select the relevant setting from the drop-down list. You can also press [F7] to open the list.

The list contains the precamber's values commonly used in accordance with the standards as well as two options for *EN 1993-1-1* and *DIN 18800 according BC* (buckling curve), respectively. The precambers according to the buckling curve are described in DIN 18800 part 2, clause 2.2. In EN 1993-1-1, the precamber is determined according to clause 5.3.2(3), Table 5.1, also depending on the buckling curve of the cross-section.

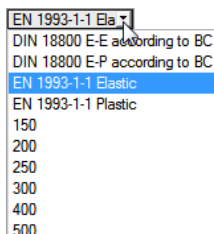

Buckling curve	Precamber $e_{0,d}$ /L elastic analysis	Precamber $e_{0,d}$ /L plastic analysis
a_0	1/350	1/300
a	1/300	1/250
b	1/250	1/200
c	1/200	1/150
d	1/150	1/100

Table 2.1: Recommended values of precamber $e_{0,d}$ /L according to EN 1993-1-1, Table 5.1

The buckling curves a_0 through d are assigned to the types of sections in accordance with EN 1993-1-1, Table 6.2.

Cross section	Limits	Buckling about axis	Buckling curve		
			S 235 S 275 S 355 S 420	S 460	
Rolled sections 	$h/b > 1,2$	y - y z - z	$t_f \leq 40$ mm	a b	a_0 a_0
			$40 \text{ mm} < t_f \leq 100$	b c	a a
	$h/b \leq 1,2$	y - y z - z	$t_f \leq 100$ mm	b c	a a
			$t_f > 100$ mm	d d	c c
Welded I-sections 	$t_f \leq 40$ mm	y - y z - z	b c	b c	
	$t_f > 40$ mm	y - y z - z	c d	c d	
Hollow sections 	hot finished	any	a	a_0	
	cold formed	any	c	c	
Welded box sections 	generally (except as below)	any	b	b	
	thick welds: $a > 0,5t_f$ $b/t_f < 30$ $h/t_w < 30$	any	c	c	
U-, T- and solid sections 		any	c	c	
L-sections 		any	b	b	

Figure 2.3: Assignment of cross-sections to buckling curves according to EN 1993-1-1, Table 6.2.

from ε_0

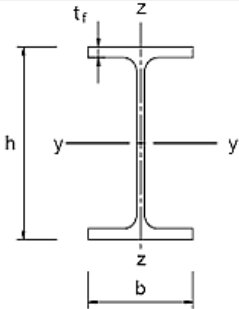
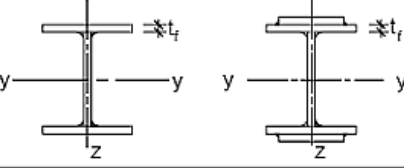
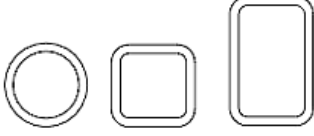
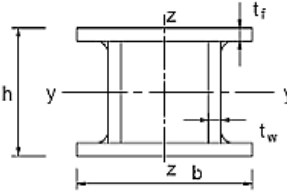
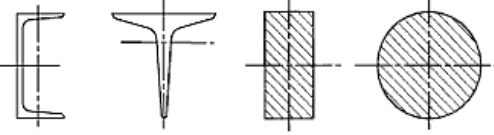
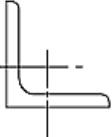

In the final table column, you specify the value of the member characteristic ε from which the precamber should be taken into account in addition to the inclination. According to DIN 18800 part 2, El. (207), the precamber is relevant starting from a member characteristic of $\varepsilon_0 = 1.6$. In EN 1993-1-1 clause 5.3.2(6), this is regulated in dependence of the slenderness ratio $\bar{\lambda}$. User-defined specifications are also possible. Furthermore, you can click [▼] in the input field to select the appropriate value.

The member characteristics (initial values for consideration of precamber and inclination) of the members and sets of members are determined by second-order analysis. If they are greater than the values ε_0 specified in column G, then the precambers are considered in the generation of the imperfections.

3. Generation

This chapter describes how imperfections are generated as equivalent lateral loads or pre-deformed initial models, and how the results are made available for RFEM.

3.1 Start the Generation

Details...

Before you start the generation of equivalent imperfections, it is recommended to check the tolerance specifications for RF-IMP. Clicking [Details] in the 1.1 *General Data* window opens the following dialog box:

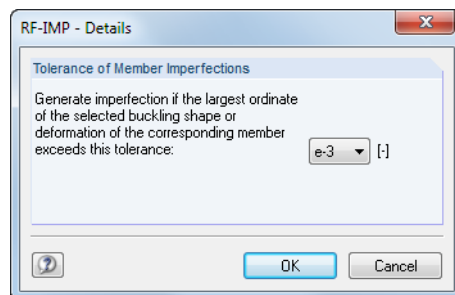
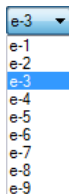

Figure 3.1: Dialog box *RF-IMP - Details*



The dialog box does not affect the generation of pre-deformed initial models.

The *Tolerance* allows you to specify the ordinate of the selected deformation or buckling mode from which imperfections will be generated: Very small amplitudes in the deformation or buckling shape are not taken into account if they are below the value given in the dialog box. Thus, RF-IMP will not apply any imperfections to members or sets of members with ordinates below this tolerance.



To specify the value of the tolerance, use the [▼] button to select it from the drop-down list. You can choose from the values *e-1* through *e-9*. The value *e-1* represents the rounding to one decimal place. If you select *e-9*, the program considers nine decimal places.

RF-IMP analyzes the scaled nodal values of the deformation or buckling shape. The maximum values are scaled to '1.' Thus, if the maximum deformation of a model is 10 cm, thus corresponding to the scaled value 1, a deflection of 0.08 cm would result in a scaled value of 0.008. If the tolerance is *e-3* (that is, has a rounding limit of three decimal places: 0.005), RF-IMP would apply an equivalent imperfection for this member because the scaled value is above the threshold. If the tolerance is *e-2*, the program would not take into account the imperfection for this member because its scaled deformation is smaller than the tolerance of 0.05 with two decimal places.

If RF-IMP cannot generate any member imperfections due to the specified tolerance, the program shows the following message.

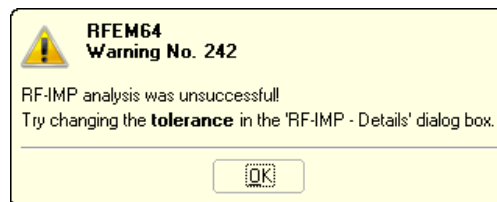
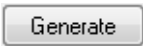

Figure 3.2: Warning if tolerance is too small

As described above, you can increase the *Tolerance* by defining several decimal places.



The [Generate] button is available in both RF-IMP input windows. Clicking it starts the generation of the load case data or the pre-deformed initial model for RFEM.

You can also start the generation in the RFEM user interface. The *To Calculate* dialog box (menu *Calculate* → *To Calculate*) lists the RF-IMP cases as well as load cases and load combinations.

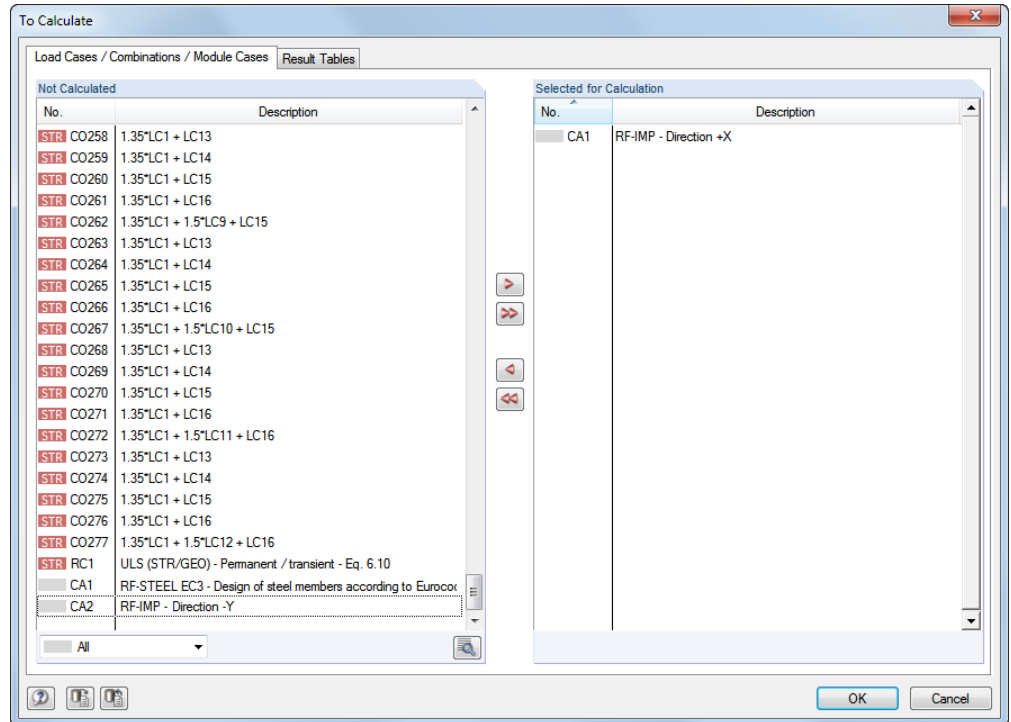
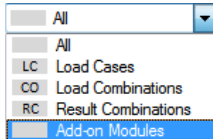

Figure 3.3: Dialog box *To Calculate*



If the RF-IMP cases are missing in the *Not Calculated* list, select *All* or *Add-on Modules* in the drop-down list at the end of the section.



To transfer the selected RF-IMP cases to the list on the right, click [▶]. Clicking [OK] starts the calculation.



To compute a design case directly, you can also use the list in the RFEM toolbar: Select the relevant RF-IMP case in the list, and then click [Show Results].



Figure 3.4: Direct calculation of an RF-IMP case in RFEM

After the successful generation, the 2.1 *Imperfections* window showing the imperfections of members and sets of members (see Figure 3.7) resp. the 2.1 *Pre-deformed Initial Model* window (see Figure 3.10) showing the shifted FE nodes appears.

After you generate the pre-deformed initial model by shifting the RFEM nodes, the following message usually appears:

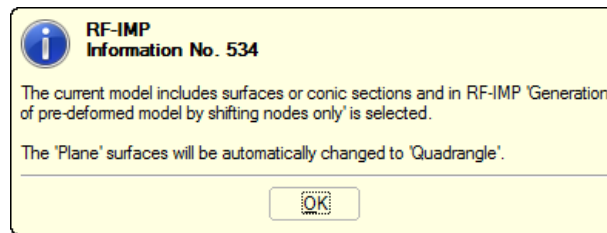

Figure 3.5: Message for plane surfaces in model

The plane surfaces must be changed to quadrangle surfaces so that the boundary lines of the surfaces can be adjusted to the diagram of the deformation or buckling modes. On [OK], RFEM runs the transformation and creates the pre-deformed initial model.

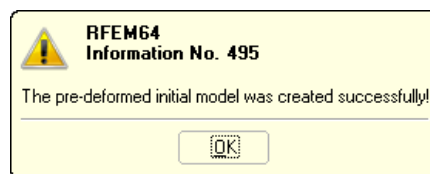

Figure 3.6: Message after generation of the pre-deformed initial model by shifting the nodes

The generation of imperfections or pre-deformed initial models is completed. If you have defined several RF-IMP cases, you have to perform the generation for each RF-IMP case separately.

If you generate a pre-deformed initial model based on already calculated deformations, the results are deleted because the deformations are no longer valid for the pre-deformed initial model.



If you run the analysis from the RFEM menu *Calculation* → *Calculate All*, all RF-IMP cases with the generation options *Imperfections of members for 3.13* and *Pre-deformed initial model - Generate pre-deformed FE mesh* are also calculated. The created imperfections are, however, not exported automatically as load cases to RFEM: This must be done in the module RF-IMP manually (see chapter 3.3). RF-IMP cases generated with the option *Generate pre-deformed model by shifting nodes only* will be excluded from the complete analysis: It would be necessary to delete all results because RF-IMP generates a modified initial model; the calculation would be trapped in a loop.

3.2 Generated Imperfections

The results for the generated *Imperfections* and the created *Pre-deformed initial model* are provided in different ways.

3.2.1 Imperfections

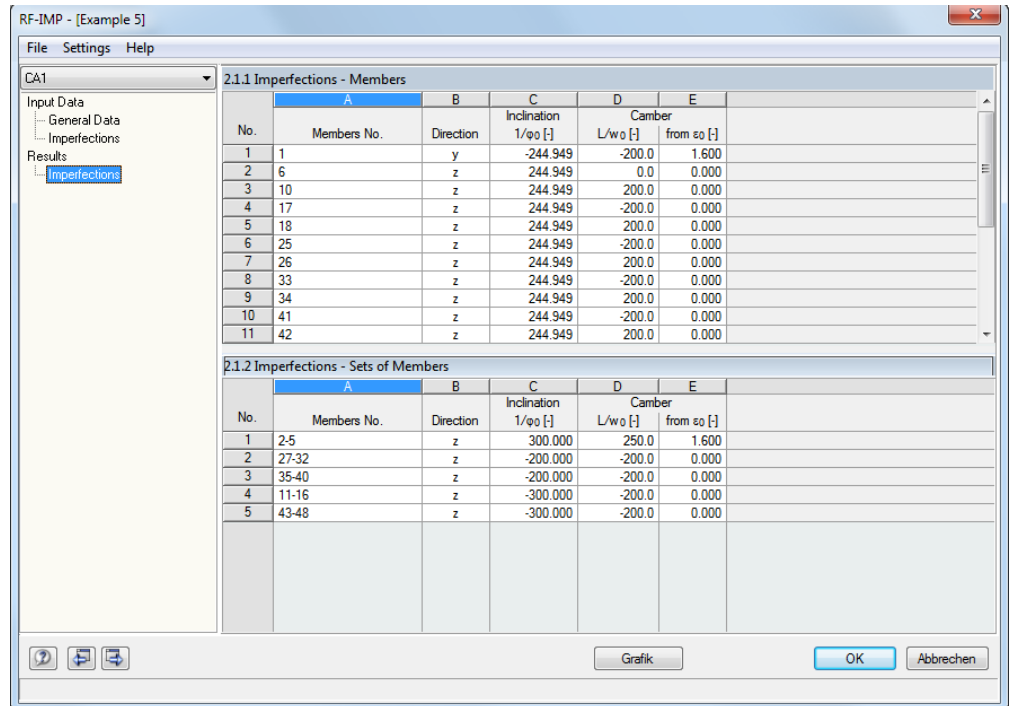

The screenshot shows the '2.1.1 Imperfections - Members' and '2.1.2 Imperfections - Sets of Members' windows. The 'Members' table lists individual members with their respective imperfection parameters. The 'Sets of Members' table lists groups of members and their collective imperfection parameters.

No.	A		C	D		E
	Members No.	Direction		Inclination 1/ε₀ [°]	Camber L/w₀ [°] from ε₀ [°]	
1	1	y	-244.949	-200.0	1.600	
2	6	z	244.949	0.0	0.000	
3	10	z	244.949	200.0	0.000	
4	17	z	244.949	-200.0	0.000	
5	18	z	244.949	200.0	0.000	
6	25	z	244.949	-200.0	0.000	
7	26	z	244.949	200.0	0.000	
8	33	z	244.949	-200.0	0.000	
9	34	z	244.949	200.0	0.000	
10	41	z	244.949	-200.0	0.000	
11	42	z	244.949	200.0	0.000	

No.	A		C	D		E
	Members No.	Direction		Inclination 1/ε₀ [°]	Camber L/w₀ [°] from ε₀ [°]	
1	2-5	z	300.000	250.0	1.600	
2	27-32	z	-200.000	-200.0	0.000	
3	35-40	z	-200.000	-200.0	0.000	
4	11-16	z	-300.000	-200.0	0.000	
5	43-48	z	-300.000	-200.0	0.000	

Figure 3.7: Window 2.1 Equivalent Imperfections

Once the generation is complete, the 2.1 *Imperfections* window appears. It is divided into two parts. Both tables list the *Members* or *Sets of Members* with the generated imperfections. The *direction* refers to the respective local member axis y or z, for the inclination and precamber.

Graphics

To graphically show the generated imperfections in the RFEM work window, click [Graphics]. The graphic shows if imperfections have been created at all members and sets of members that are susceptible to buckling.

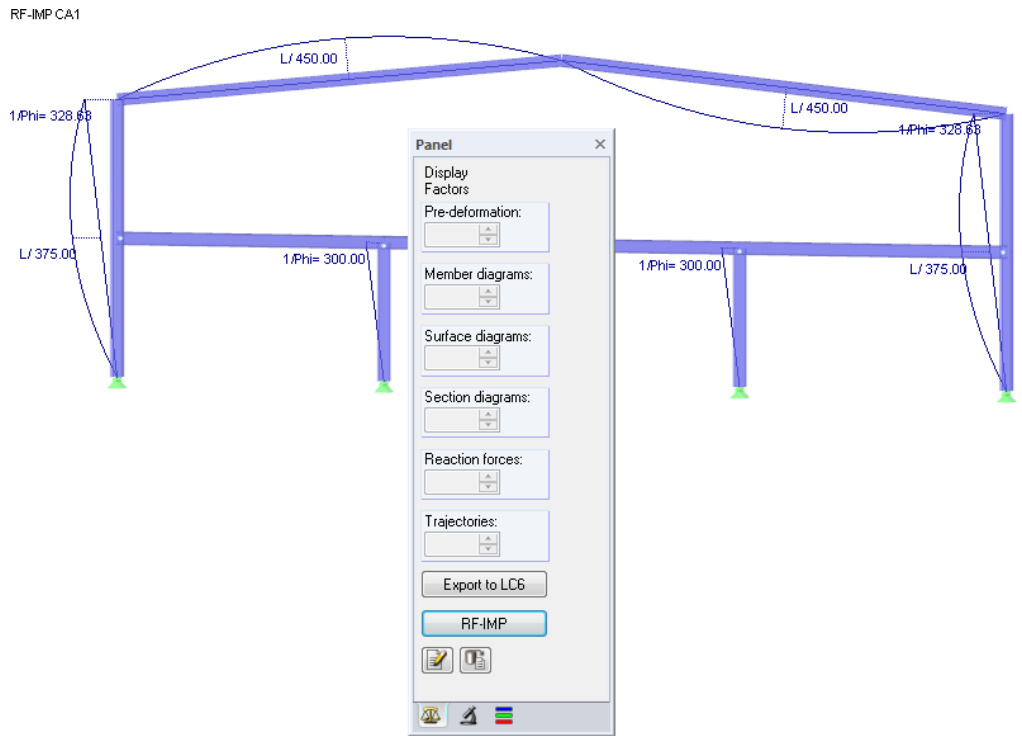

Figure 3.8: RFEM graphic of the generated equivalent imperfections

You can hide or unhide the local member axes by using the context menu of a member or specify this in the *Display* navigator.

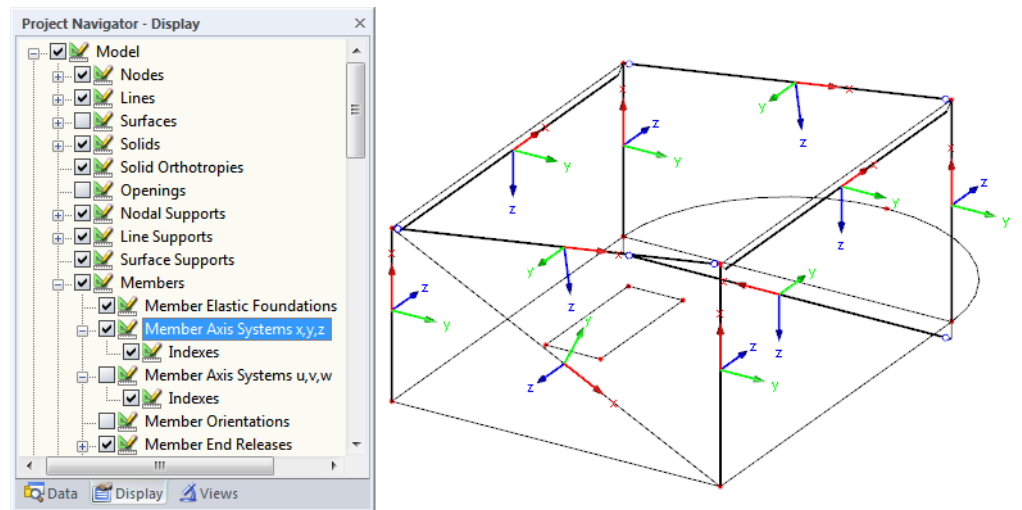

Figure 3.9: Activating the member axis systems in the *Display* navigator

RF-IMP

By clicking [RF-IMP] in the panel, you return to the module RF-IMP to change the input there and start a new generation.

3.2.2 Pre-Deformed Initial Model

Pre-deformed FE Mesh

If you select the *Generate pre-deformed FE mesh* option, the 2.1 *Pre-deformed Initial Model* window appears. It is divided into two parts. Both tables list the displacements of the FE nodes for the individual *Surfaces* or *Sets of Members* with the generated imperfections. The *Pre-deformations* refer to the global XYZ coordinate system.

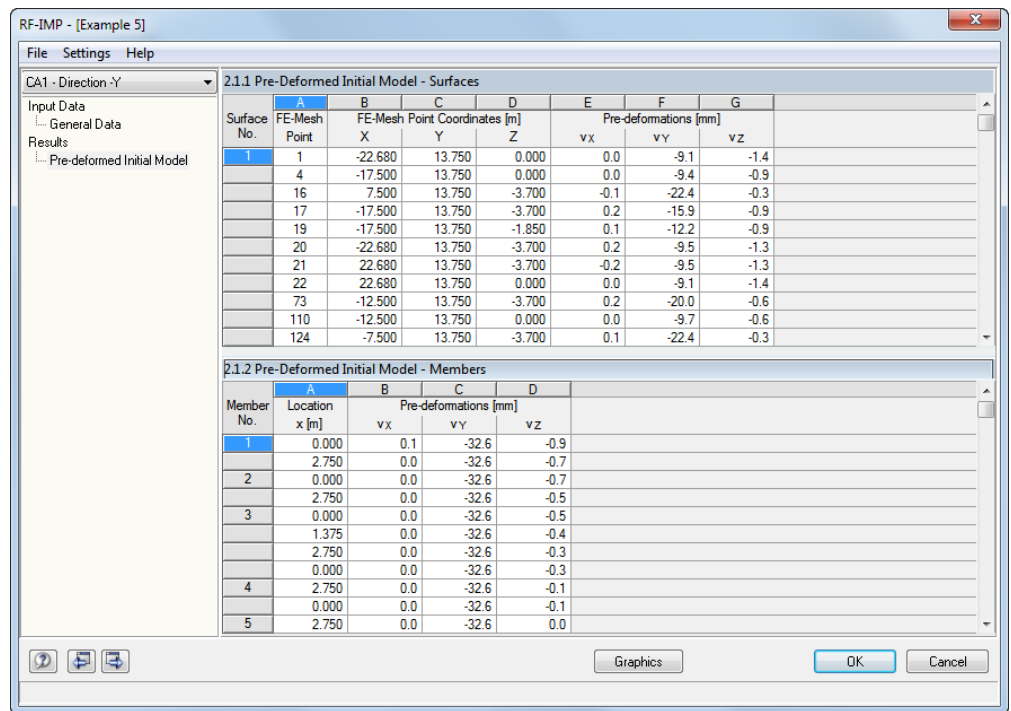

Figure 3.10: Window 2.1 *Pre-deformed initial model*

Chapter 5, page 28 presents an example for the generation of a pre-deformed initial model.

Pre-deformed initial model

After you generate the pre-deformed initial model, the message shown in Figure 3.5 appears. On [OK], RFEM transforms the plane surfaces into quadrangle surfaces and creates the pre-deformed initial model. The input is complete.

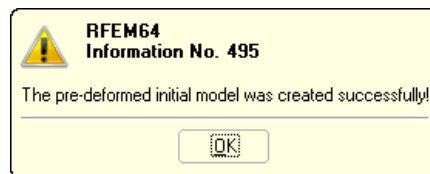

Figure 3.11: Message after generation of the equivalent model by shifting the nodes



In the pre-deformed initial model, the nodal coordinates are adjusted. To check this, for example, in the 1.1 *Nodes* table of RFEM, close the module RF-IMP by clicking [OK] or [Cancel].

In the centers of the members and surfaces, no adjustments are made because only the coordinates of the RFEM nodes are changed.

3.3 Export of Imperfections

This chapter describes how the generated *Equivalent imperfections of members* can be exported as load case to RFEM and how the *Generation of the pre-deformed FE mesh* can be used in the RFEM load combinations.

3.3.1 Imperfections

To export the generated imperfections to RFEM, click [OK]. The following dialog box appears:

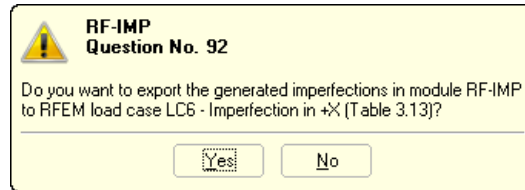
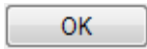
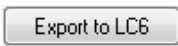

Figure 3.12: Query before exporting the load case data



As shown in Figure 3.8, you can find an export option also in the graphical user interface of RFEM. The panel offers you the [Export to LC] button by clicking which the message shown above opens.

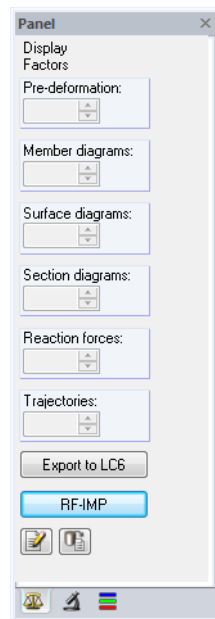

Figure 3.13: Panel with *Export* button

The imperfections are entered in the RFEM table 3.13. If necessary, you can adjust them there or add specifications.

3.3.2 Pre-Deformed FE Mesh

The displacements of the FE nodes are saved internally. They do not need to be exported.

In RFEM, you can apply the pre-deformed FE mesh for the calculation of a load combination. Open the *Edit Load Cases and Combinations* dialog box in RFEM and select the relevant load combinations in the *Load Combinations* tab. In the *Calculation Parameters* subtab, select the **Activate extra options** check box.

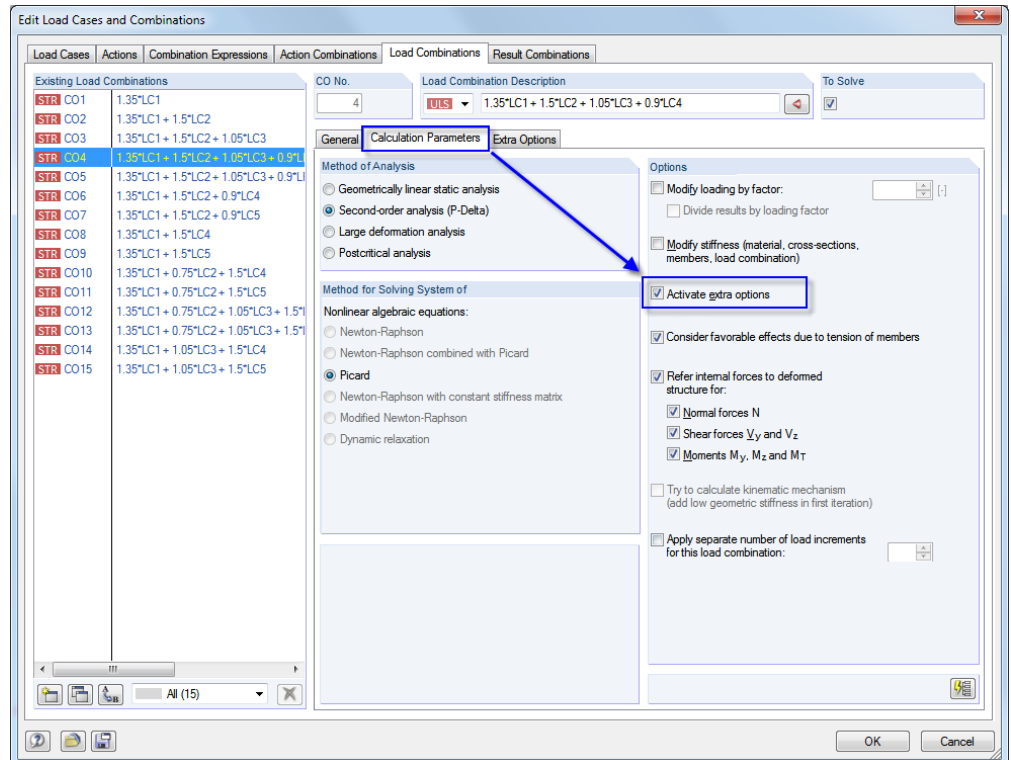

Figure 3.14: Dialog box *Edit Load Cases and Combinations*, tab *Calculation Parameters*

Thus, the *Extra Options* tab becomes available. Select the check box **Activate generated imperfections from add-on module RF-IMP**. In the list, you can then select the governing RF-IMP case (see the following figure).

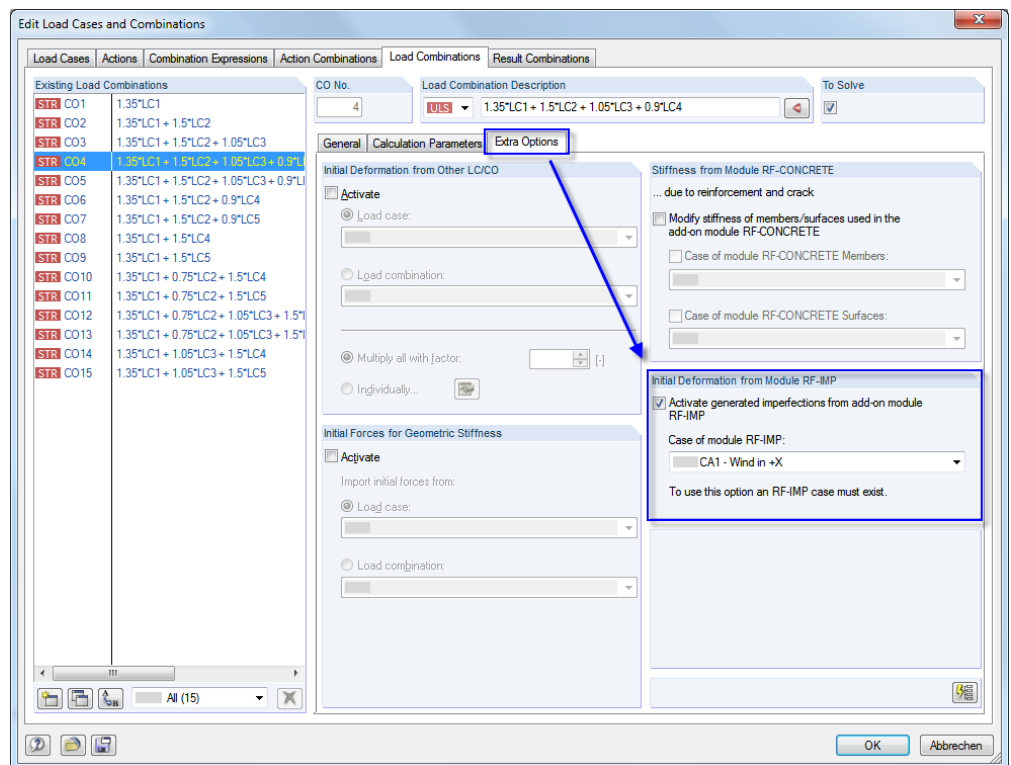

Figure 3.15: Assigning an RF-IMP case in the tab *Add-on Options*

In this way, you can assign the pre-deformations of RF-IMP cases to certain load combinations. This has the advantage that the model data cannot be changed. Thus it is possible to consider different pre-deformed initial models in one single RFEM model.



Chapter 7.3.1.3 of the RFEM manual describes the *Extra Options* tab in more detail.

The example in chapter 5 shows how the deformed FE mesh of a pre-deformed initial model is considered in one load combination in RFEM.

4. General Functions

This chapter describes useful menu functions and further export options for the RF-IMP cases.

4.1 RF-IMP cases

RF-IMP cases allow you to group the generation parameters of the members or sets of members according to certain specifications. In this way, you can generate certain load cases or buckling modes in different RF-IMP cases in order to generate specific imperfections. For some members and surfaces, imperfections can be governing that depend on certain loadings or buckling/plate-buckling modes. According to the state of the art, they must consequently be taken into account separately in individual load cases.



If there are several load cases, you should pay attention to the numbers of the target load cases to prevent unintentional overwriting.

Create New RF-IMP Case

To create a new RF-IMP case, select the command on the RF-IMP menu

File → New Case.

The following dialog box appears:

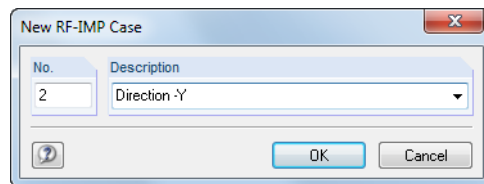

Figure 4.1: Dialog box *New RF-IMP Case*

In this dialog box, enter a *number* (one that is still free) for the new RF-IMP case. The *Description* will help you select the right case from the load case list.

Upon clicking [OK], the 1.1 *General Data* RF-IMP window for the input of parameters appears.

Rename RF-IMP Case

To change the description of an existing RF-IMP case, use the command on the RF-IMP menu

File → Rename Case.

The following dialog box appears:

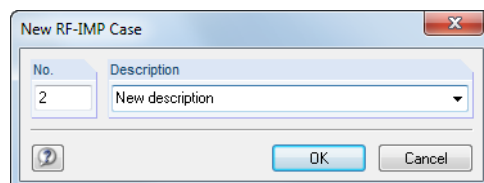

Figure 4.2: Dialog box *Rename RF-IMP Case*

In this dialog box, you can specify a different *Description* as well as a different *No.* for the RF-IMP case.

Copy RF-IMP Case

To copy the input data of the current case, use the command from the RF-IMP menu

File → Copy Case.

The following dialog box appears:

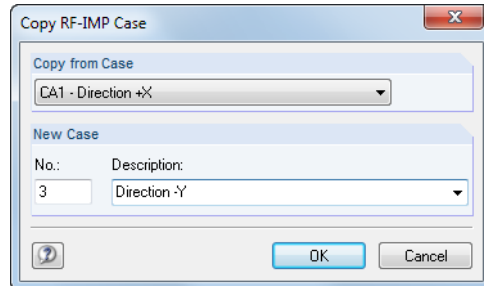

Figure 4.3: Dialog box *Copy RF-IMP Case*

Specify the *Number* and, if necessary, a *Description* for the new RF-IMP case.

Delete RF-IMP Case

To delete generation cases, use the command on the RF-IMP menu

File → Delete Case.

The following dialog box appears:

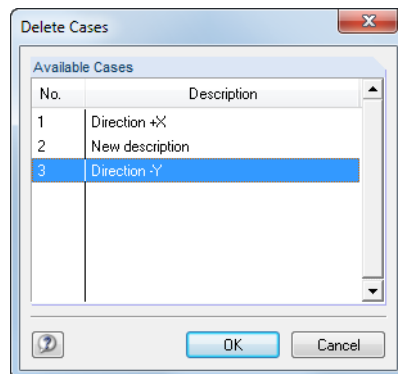

Figure 4.4: Dialog box *Delete Cases*

The case can be selected in the *Available Cases* list. To delete the selected case, click [OK].

4.2 Units and Decimal Places

The units and decimal places for RFEM and the add-on modules are managed together in a common dialog box. In RF-IMP, you can define the units by selecting the command from the RF-IMP menu

Settings → **Units and Decimal Places**.

The dialog box known from RFEM appears. In the *Program / Module* list, RF-IMP is preset.

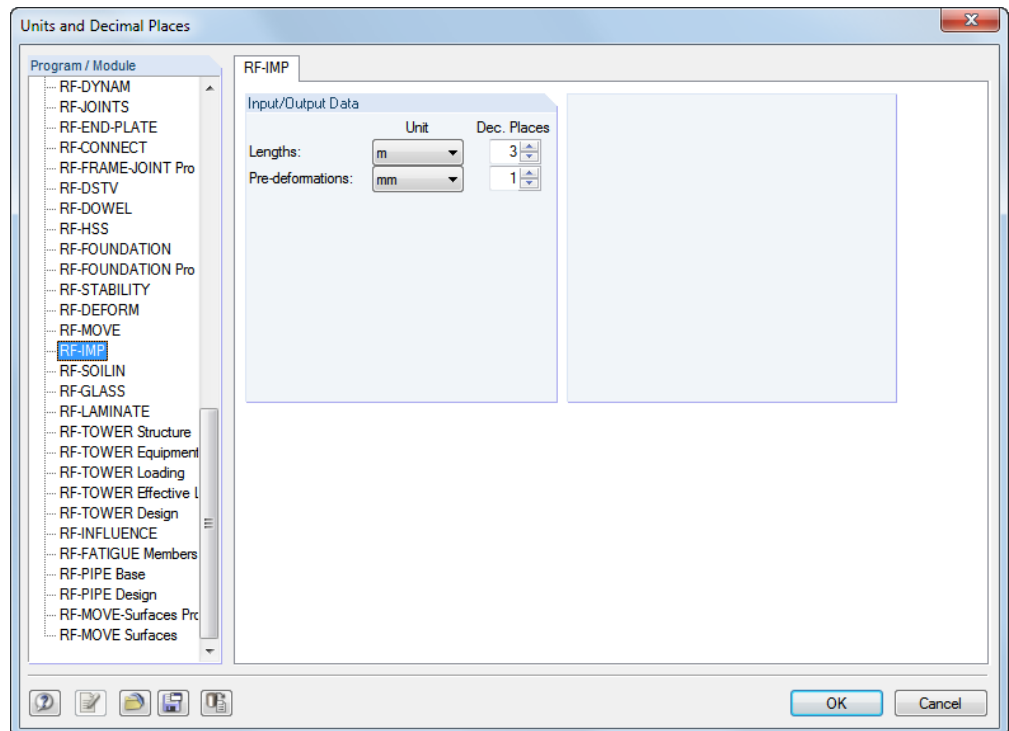

Figure 4.5: Dialog box *Units and Decimal Places*



You can save the settings as user profile to reuse them in other models. These functions are described in chapter 11.1.3 of the RFEM manual.

4.3 Export of Data

The data export of the generated equivalent imperfections is primarily flowing in the direction of the main program RFEM: Then, RFEM creates an imperfection load case that you can adjust or complete (see chapter 3.3, page 21). With some restrictions, it is also possible to prepare data from RF-IMP directly for other programs.

Clipboard

To copy cells selected in the 1.2 *Imperfections* and 2.1 *Imperfections* windows to the Clipboard, press [Ctrl]+[C]. To insert the cells, for example in a word processing program, press [Ctrl]+[V]. The headers of the table columns will not be transferred.

Printout Report

Data from RF-IMP cannot be integrated directly into the printout report. However, you can export the imperfections created in the RFEM load cases. To do this, select in the report menu

File → **Export in RTF**.

The function is described in detail in chapter 10.1.11 of the RFEM manual.

Excel / OpenOffice

RF-IMP provides a function for the direct data export to MS Excel, OpenOffice.org Calc, or the file format CSV. To start this function, select the command from the menu

File → Export Tables.

The following export dialog box appears.

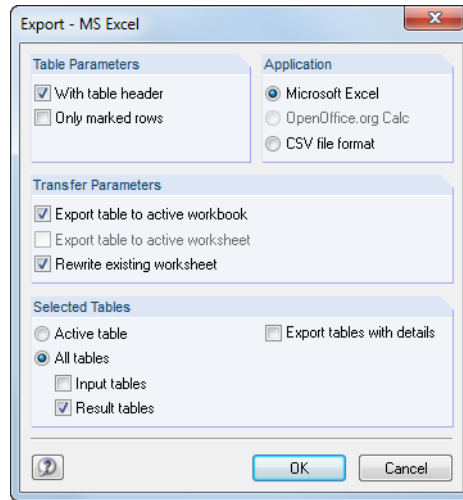

Figure 4.6: Dialog box *Export - MS Excel*

Following the design concept of the add-on module, only the two windows 1.2 *Imperfections* and 2.1 *Imperfections* or *Pre-deformed initial model* are considered for the data export.

Click [OK] to start the export. Excel or OpenOffice will be started automatically, that is, the programs do not have to be opened first.

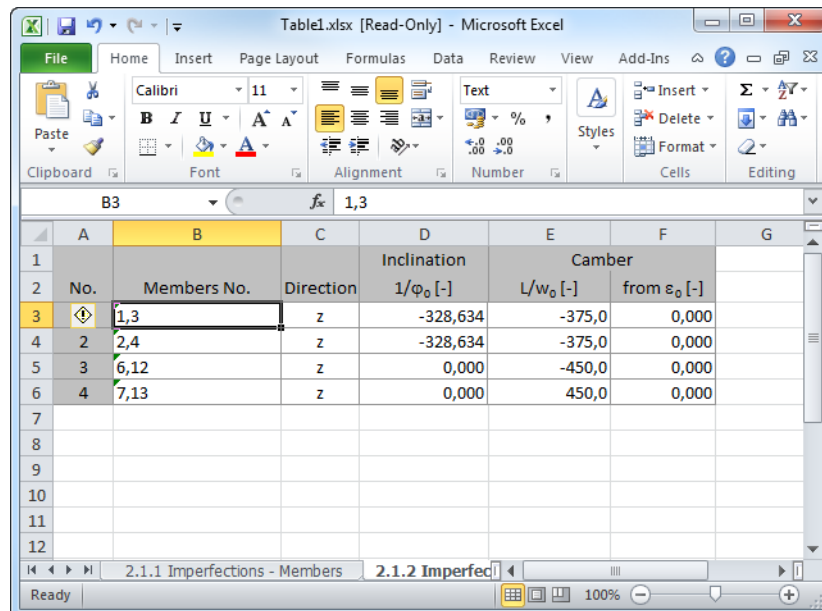

Figure 4.7: Result in MS Excel

5. Example: Pre-Deformed Model

A tapered cantilevered beam with openings was created in RFEM. The imperfections for these systems are to be generated as pre-deformed initial models.

First, the plate-buckling modes for the load case imposed load are computed in the module RF-STABILITY.

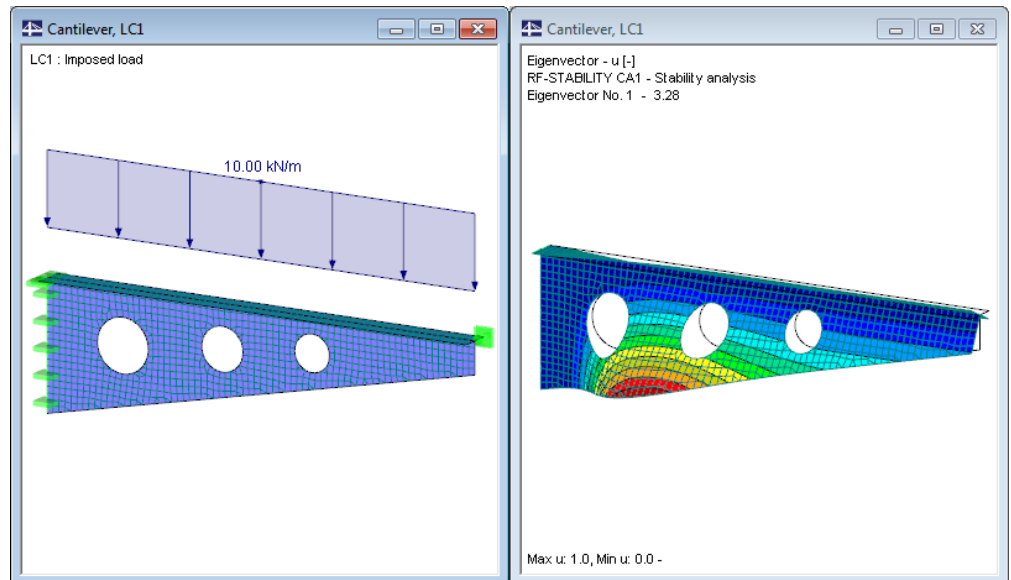

Figure 5.1: Cantilever subjected to imposed load and buckling shape (eigenmode 1)

After starting RF-IMP, we make the following specifications in the 1.1 *General Data* window:

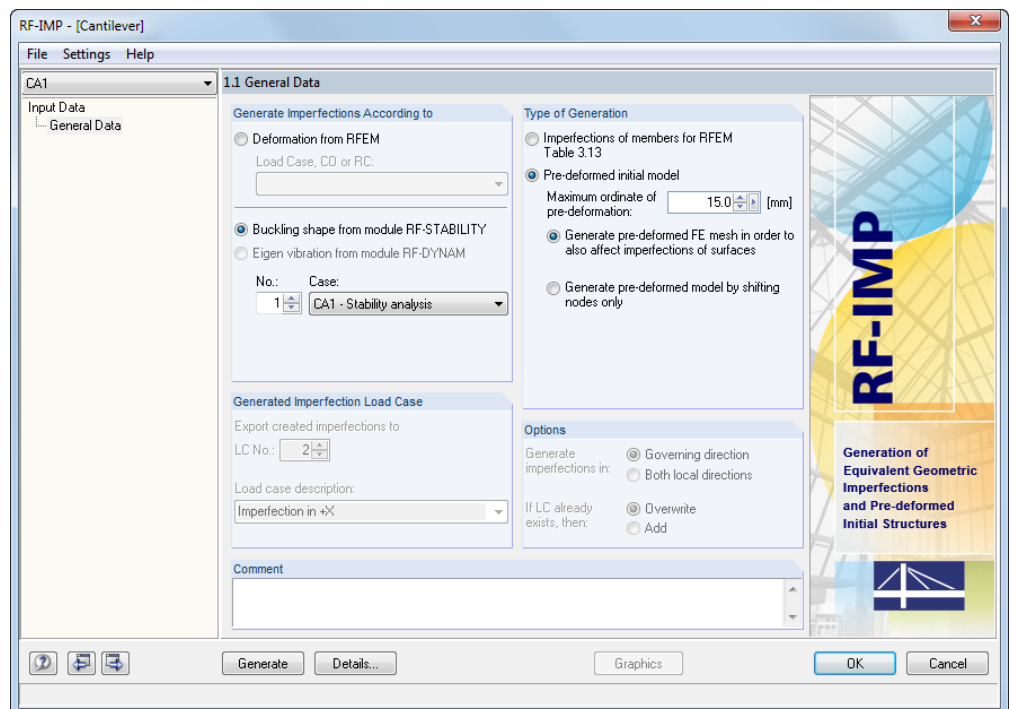

Figure 5.2: RF-IMP window 1.1 *General Data*

The imperfections are created based on the RF-STABILITY eigenmode No. 1. The *maximum ordinate of pre-deformation* is **15 mm**. The input is complete.

5 Example: Pre-Deformed Model

Generate

We [Generate] the pre-deformed initial model. Then, the shifted FE nodes of the surfaces in window 2.1.1 *Pre-deformed initial model* are shown in a table.

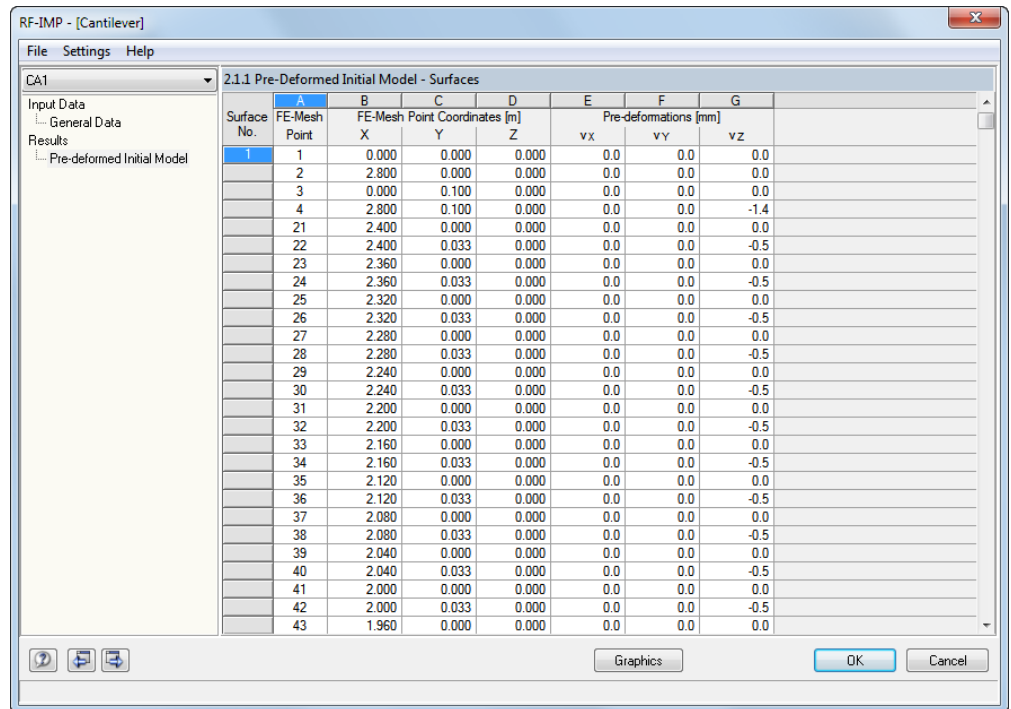

Surface No.	FE-Mesh Point	FE-Mesh Point Coordinates [m]			Pre-deformations [mm]		
		X	Y	Z	vX	vY	vZ
1	1	0.000	0.000	0.000	0.0	0.0	0.0
2	2	2.800	0.000	0.000	0.0	0.0	0.0
3	3	0.000	0.100	0.000	0.0	0.0	0.0
4	4	2.800	0.100	0.000	0.0	0.0	-1.4
21	21	2.400	0.000	0.000	0.0	0.0	0.0
22	22	2.400	0.033	0.000	0.0	0.0	-0.5
23	23	2.360	0.000	0.000	0.0	0.0	0.0
24	24	2.360	0.033	0.000	0.0	0.0	-0.5
25	25	2.320	0.000	0.000	0.0	0.0	0.0
26	26	2.320	0.033	0.000	0.0	0.0	-0.5
27	27	2.280	0.000	0.000	0.0	0.0	0.0
28	28	2.280	0.033	0.000	0.0	0.0	-0.5
29	29	2.240	0.000	0.000	0.0	0.0	0.0
30	30	2.240	0.033	0.000	0.0	0.0	-0.5
31	31	2.200	0.000	0.000	0.0	0.0	0.0
32	32	2.200	0.033	0.000	0.0	0.0	-0.5
33	33	2.160	0.000	0.000	0.0	0.0	0.0
34	34	2.160	0.033	0.000	0.0	0.0	-0.5
35	35	2.120	0.000	0.000	0.0	0.0	0.0
36	36	2.120	0.033	0.000	0.0	0.0	-0.5
37	37	2.080	0.000	0.000	0.0	0.0	0.0
38	38	2.080	0.033	0.000	0.0	0.0	-0.5
39	39	2.040	0.000	0.000	0.0	0.0	0.0
40	40	2.040	0.033	0.000	0.0	0.0	-0.5
41	41	2.000	0.000	0.000	0.0	0.0	0.0
42	42	2.000	0.033	0.000	0.0	0.0	-0.5
43	43	1.960	0.000	0.000	0.0	0.0	0.0

Figure 5.3: RF-IMP window 2.1.1 *Pre-deformed initial model* - Surfaces

We close RF-IMP by clicking [OK]. The RFEM work window shows the following figure:

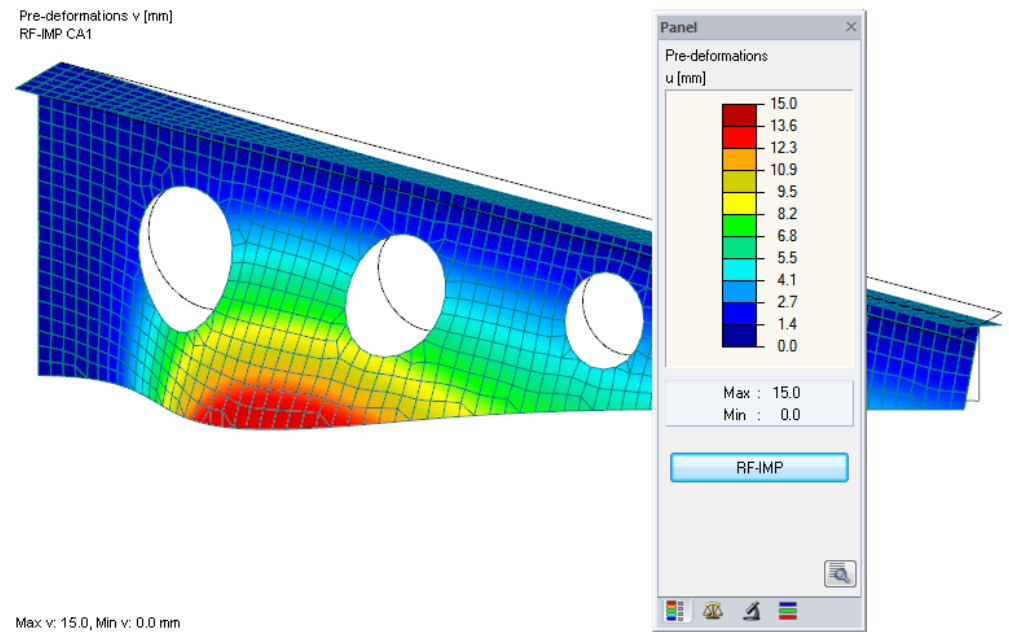

Figure 5.4: Pre-deformed FE mesh

The pre-deformed FE mesh in RFEM can be considered for the computation of a load combination. To do this, open the *Edit Load Cases and Combinations* dialog box and select the *Calculation Parameters* tab. Now select the **Activate extra options** check box.

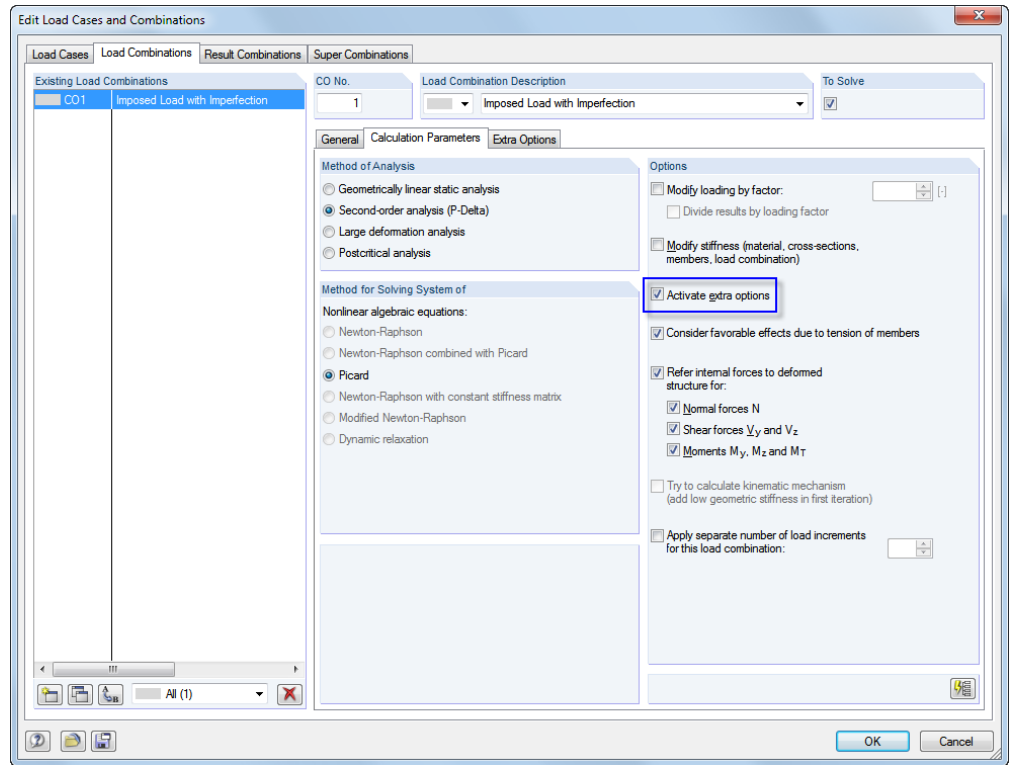

Figure 5.5: RFEM dialog box *Edit Load Cases and Combinations*, tab *Calculation Parameters*

In the *Extra Options* tab, you can activate the RF-IMP initial deformation.

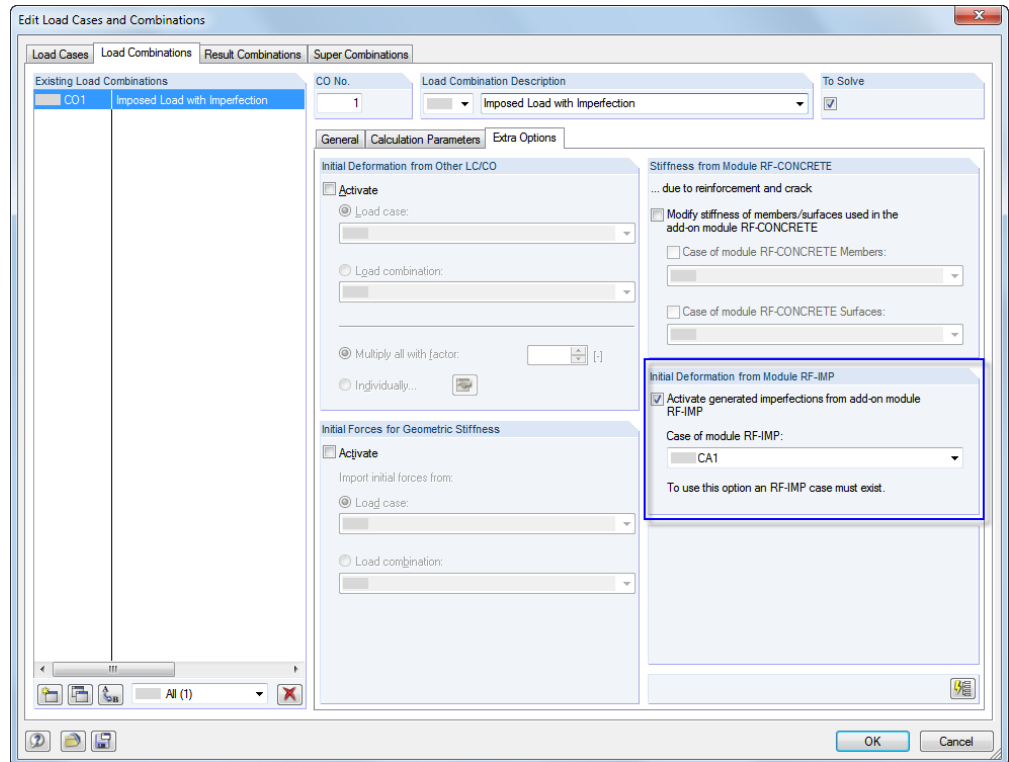

Figure 5.6: RFEM dialog box *Edit Load Cases and Combinations*, tab *Calculation Parameters*

A Literature

- [1] DIN 18800 (11.90) Teil 1: Stahlbauten - Bemessung und Konstruktion, Beuth Verlag, Berlin/Wien/Zürich, 1992
- [2] DIN 18800 (11.90) Teil 2: Stahlbauten - Stabilitätsfälle, Knicken von Stäben und Stabwerken, Beuth Verlag, Berlin/Wien/Zürich, 1992
- [3] DIN 1045-1: Tragwerke aus Beton, Stahlbeton und Spannbeton
Teil 1-1: Bemessung und Konstruktion, 2001
- [4] DIN 1052:2008-12: Entwurf, Berechnung und Bemessung von Holztragwerken
Allgemeine Bemessungsregeln und Regeln für den Hochbau, 2008
- [5] EN 1992-1-1: Design of concrete structures
Part 1-1: General rules and rules for buildings
- [6] EN 1993-1-1: Design of steel structures
Part 1-1: General rules and rules for buildings, 2005.

B Index

A	
Add.....	10
B	
BC.....	12
Browsing through windows.....	7
Buckling curve.....	12, 13
Buckling shape.....	8
C	
Comment.....	10
CSV-Export.....	27
D	
Data export.....	26
Decimal places.....	11, 26
Definition.....	11, 12
Deflection.....	10
Deformation.....	8
Details.....	10, 15
DIN.....	11
E	
Eigen vibration.....	9
Elastic analysis.....	11, 12, 13
Epsilon ϵ_0	14
Equivalent imperfections.....	9, 18
Equivalent model.....	9, 17, 20
Eurocode.....	11
Excel.....	27
Exit RF-IMP.....	7
Export.....	21, 26
F	
FE nodes.....	9, 20, 22, 29
G	
General data.....	8
Generation.....	15
Generation case.....	24
Governing direction.....	10
Graphic.....	18, 21
I	
Imperfection load case.....	9
Imperfections.....	10, 18
Inclination.....	11, 12
Installation.....	5
L	
Length.....	11
Load case.....	9
Load combination.....	9, 22, 30
M	
Manually.....	12
Member characteristic.....	14
Member rotation.....	11
Members.....	9, 11, 18
Module windows.....	7
N	
n causes.....	12
Navigator.....	7
O	
OpenOffice.....	27
Options.....	10
Ordinate of pre-deformation.....	9
Overwrite.....	10
P	
Plastic analysis.....	11, 12, 13
Plate-buckling mode.....	28
Precamber.....	12
Pre-deformed FE mesh.....	9, 20
Pre-deformed initial model.....	9, 15, 17, 20, 28
Program start.....	6
R	
Reduction factor.....	12
Result combination.....	8
RF-DYNAM.....	9
RF-IMP case.....	9, 17, 22, 24, 25
RF-STABILITY.....	8, 28
S	
Sets of members.....	11, 18
Shifting nodes.....	9
Start RF-IMP.....	6
Start the generation.....	15
System length.....	12
T	
Tolerance.....	10, 15
Type of generation.....	9

U

Units..... 11, 26

W

Windows.....7